

# CHIAYO

Operation manual

## APEX PRO

Portable Wireless PA System

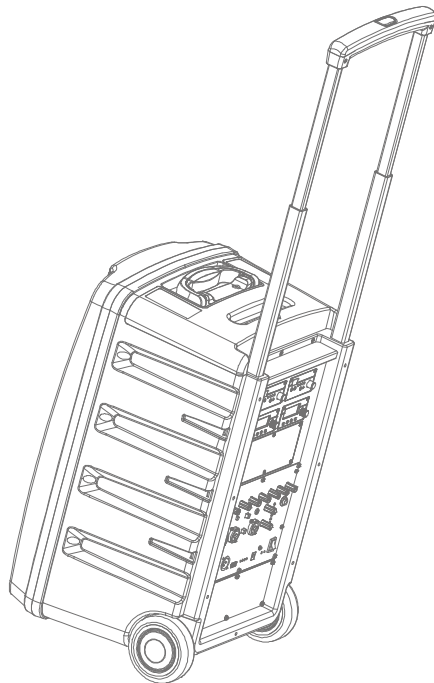

CHIAYO ELECTRONICS CO., LTD.

## **Important safety instructions**

- Read all of the instructions before the product is operated.
- Keep these instructions well for future reference.
- Follow all of the warnings and instructions when installing, setting up and using the product.
- Only clean the product when it is not connected to the power supply system. Clean only with a dry cloth.
- Keep ventilation openings unblocked and follow with the manufacturer's instructions for installation.
- Do not immerse product in any liquid or expose to heat or moisture
- Keep the complete polarized or grounding type plug without any modification. A polarized plug has two blades with one wider than the other. A grounding type plug has two blades and a third grounding prong. The wider blade or the third prong are provided for your safety. If the provided plug does not fit into your outlet, consult an electrician for replacement of the obsolete outlet.
- Power supply cords should be well routed to prevent from being walked on or pinched by items placed upon or against them, particularly at plugs, convenience receptacles, and the point where they exit from the product.
- Use only manufacturer authorized or recommended accessories.
- Use only with a cart, stand, tripod or accessories specified or provided by Chiayo. Be careful when using a cart to avoid injury from tip-over.
- Unplug the product during an electrical storm or when unused for long periods of time.
- Never disassemble, modify or service the product. Any unauthorized modifications may result in personal injury and/or product failure. Additionally, your warranty will be void.
- Operation Temperature: 35 Degree Celsius Maximum.

## Warning

Please read and follow the instructions in this manual thoroughly to obtain optimum results from this unit. We also recommend that you keep this manual handy for future reference.

## Safety Precautions

- Be sure to read the instructions in this section carefully before use.
- Make sure to observe the instructions in this manual as the conventions of safety symbols and messages regarded as very important precautions are included.

Safety symbols and messages described below are used in this manual to prevent bodily injury and property damage which could result from mishandling. Before operating your product, read this manual first and understand the safety symbols and messages so you are thoroughly aware of the potential safety hazards.



### WARNING

Indicates a potentially hazardous situation which, if mishandled, could result in death or serious personal injury.



### CAUTION

Indicates a potentially hazardous situation which, if mishandled, could result in moderate or minor personal injury, and/or property damage.

Make sure to observe the following handling precautions so that a fire or personal injury does not result from leakage or explosion of the battery.

- Do not short, disassemble, heat or put the battery into a fire.
- Never charge batteries of the type which are not rechargeable.
- Do not solder a battery directly.
- Be sure to use the specified type of battery.
- Note the correct polarity when inserting a battery in the unit.
- Avoid locations exposed to the direct sunlight, high temperature and high humidity when storing batteries.
- Disposal of a battery into fire or a hot oven, or mechanically crushing or cutting of a battery, that can result in an explosion;
- Leaving a battery in an extremely high temperature surrounding environment that can result in an explosion or the leakage of flammable liquid or gas;
- A battery subjected to extremely low air pressure that may result in an explosion or the leakage of flammable liquid or gas.



### WARNING

To prevent the electromagnetic wave from badly influencing medical equipment, make sure to switch off the unit's power when placing it in close proximity to the medical equipment.



### CAUTION

Battery discharge naturally according to a certain pattern even not in use. For best performance and a prolonged lifespan, battery **should** be charged regularly after every use or every month when the system is in storage and not being used!

CD player optical pick up head is a very delicate device and sensitive to humidity. Please avoid using it in high humidity area to avoid damage!

## INDEX

1. Instruction .....	4
1-1 In the box .....	4
1-2 Optional related products .....	4
1-3 Parts and functions .....	5
1-4 Charging the battery .....	6
1-5 Module compartment .....	7
1-6 Connection with external audio sources .....	7
2. Settings and Operations .....	8
2-1 Using the wired microphone (MIC 1, MIC 2) .....	8
2-2 Using the wireless receiver .....	9
2-2-1 Parts and functions .....	9
2-2-2 Channel synchronization of the receiver and transmitter .....	9
2-2-3 Channel scanning .....	10
2-2-4 Squelch (SQ) setting .....	10
2-2-5 Volume and other settings .....	11
2-3 Using the electronic instrument (MIC 1, MIC 2) .....	12
2-4 Using the electronic instrument (LINE IN) .....	13
2-5 Music audio input (LINE IN)- Smart phone / tablet / MP3 player .....	14
2-6 Music audio input (DIGITAL IN)- Computer/notebook .....	15
2-7 Operating BLUETOOTH receiver (BLUETOOTH) .....	16
2-8 EQUALIZER for WIRED and WIRELESS MICROPHONE and MUSIC .....	17
2-9 VOICE PRIORITY .....	18
2-10 REVERB .....	18
2-11 Limiter Function .....	18
3. Application .....	19
3-1 Active audio link: APEX PRO to APEX PRO .....	19
3-2 Active audio link: APEX PRO to APEX SLAVE .....	20
3-3 Wireless audio link: repeat all audio to linked APEX PRO / APEX SLAVE .....	21
3-3-1 Parts and functions of RP-5100M .....	21
3-3-2 Changing channels .....	21
3-3-3 Music audio input (AUX IN)- Smart phone / tablet / MP3 player .....	22
3-3-4 Adjust internal audio gain level .....	22
3-3-5 Output power setting .....	22
3-4 More extension .....	24
3-5 Connecting a passive companion speaker .....	25
4. Installing or replacing a receiver/repeater/MP3 module .....	26
5. Operation of the storage for transmitters and accessories .....	27
6. FAQ & useful operation tips .....	28
7. Maintenance-free Lead-acid and Lithium batteries .....	30

## 1. Instruction

Congratulations and thank you for purchasing this all-in-one portable sound system. To ensure a trouble-free operation, please read the manual thoroughly to fully understand its controls and functions.

The rear panel of these portable sound systems is divided into 3 sections:

1. Module compartment
2. Control Unit compartment
3. Battery compartment

The Modules Compartment can be user configurable and user can access the battery compartment to change battery.

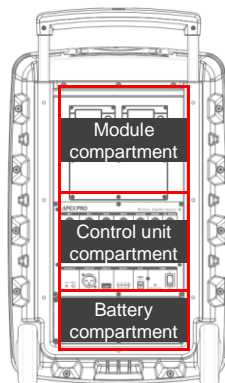

### 1-1 In the box

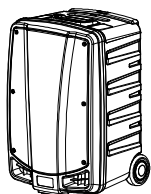

APEX PRO amplifier



0-4 handheld / belt-pack transmitters (optional)

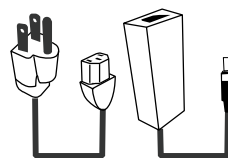

switching power supply (plug varies from country to country)



operation manual

### 1-2 Optional related products

■ **Modules & transmitters** (For more information about transmitter, please refer to its user manual)

<b>SDR-8200M IrDA</b>	Ture diversity receiver module	<b>SQ-6100 IrDA</b> <b>SQ-5100 IrDA</b>	Handheld microphone
<b>SDR-8100M IrDA</b>	Diversity receiver module	<b>SM-7100 IrDA</b> <b>SM-6100 IrDA</b>	Belt-pack transmitter
<b>DWR-5410M</b>	2.4G digital receiver module	<b>DH-5400</b>	Handheld digital microphone
		<b>DB-5400</b>	Belt-pack digital transmitter
<b>RP-5100M</b>	Repeater module	<b>DPR-500m</b>	MP3 recorder module

■ **Speakers**

<b>APEX SLAVE</b>	Active companion powered speaker	<b>APEX SP</b>	Passive companion speaker
-------------------	----------------------------------	----------------	---------------------------

■ **Accessories**

<b>ST-50</b>	Tripod stand: standard	<b>ST-51</b>	Tripod stand: height adjustable
<b>DC-55</b>	Weather proof dust cover	<b>DM-series</b>	Wired microphone, please refer to <b>CHIAYO website</b> .

1-3 Parts and functions

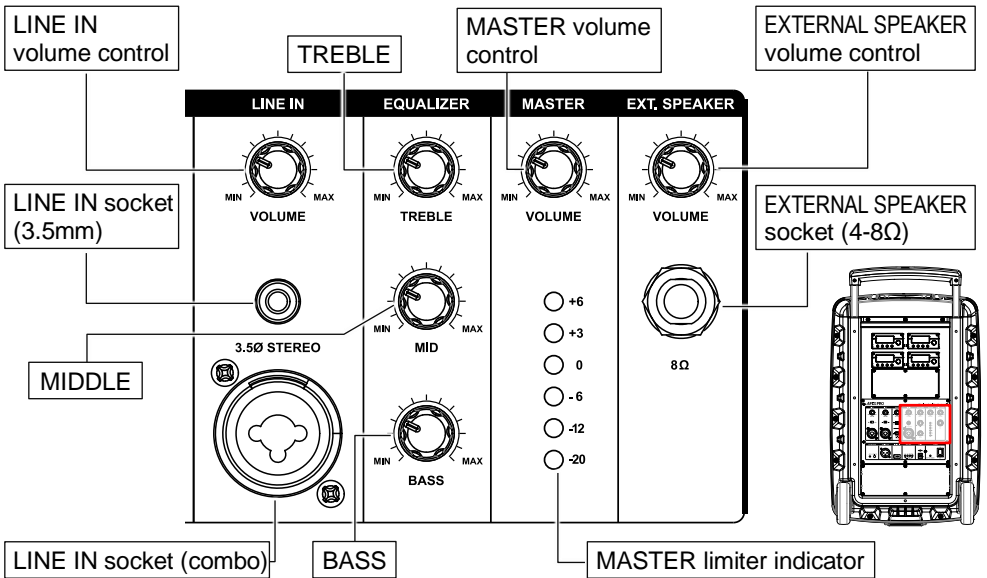
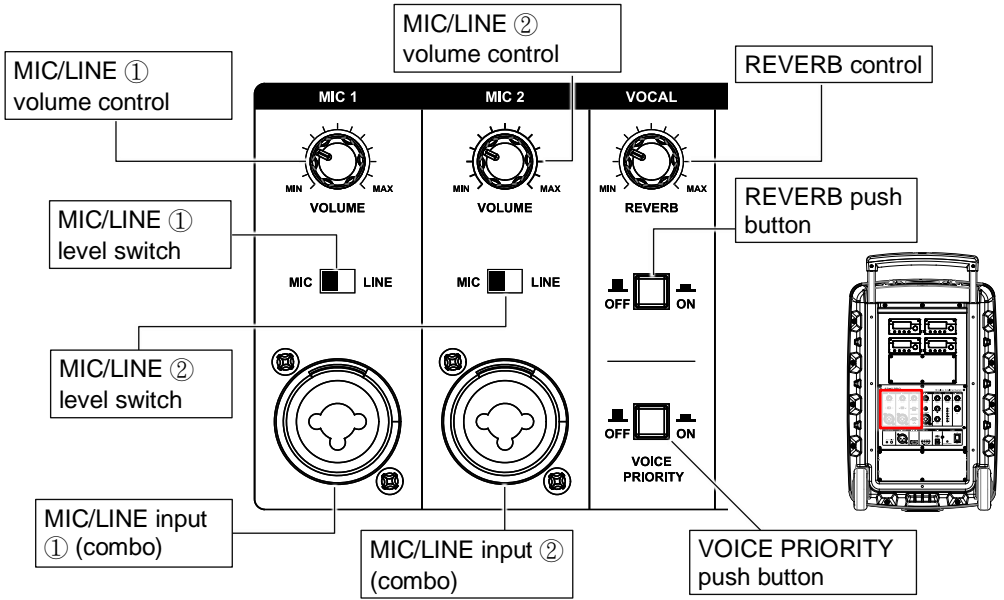

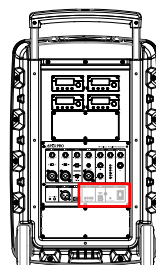
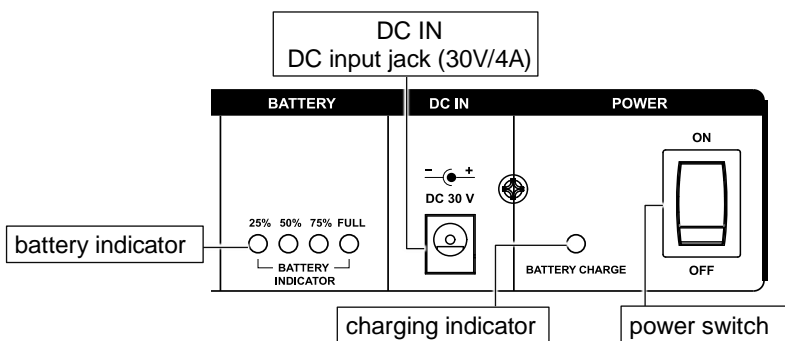
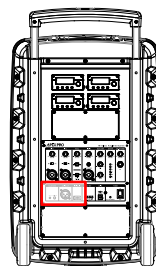
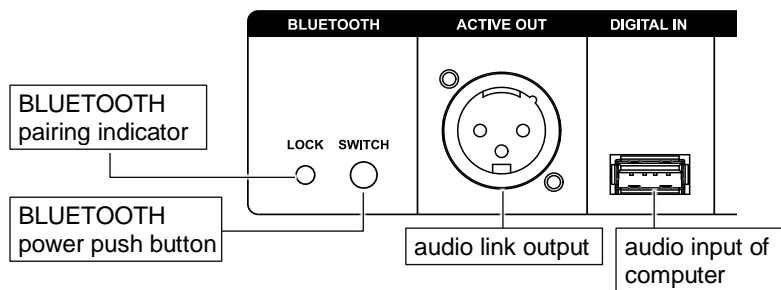

### 1-4 Charging the battery

This amplifier uses either two lead-acid batteries or one lithium battery. The battery power is leveled from 25%, 50%, 75% and FULL. If the LED stays at 50%, the battery might not be sustainable for long operation.

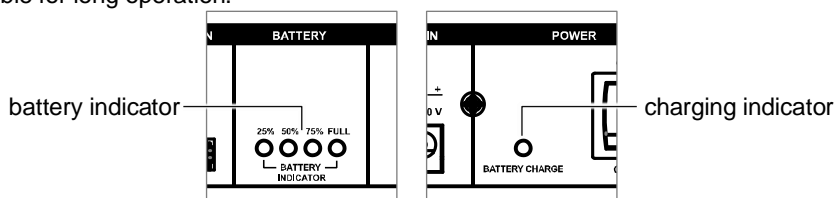

Charging indicator	Condition
Flashes RED	During recharging
Solid GREEN	Fully charged
Solid YELLOW	Error or no battery detected

### 1-5 Module compartment

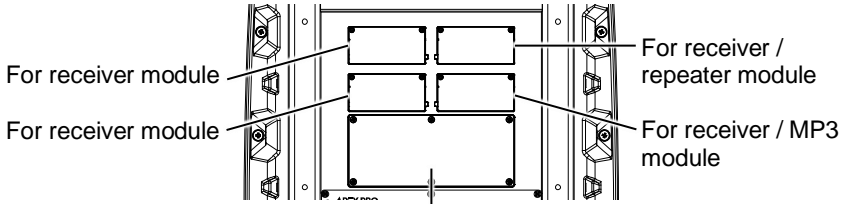

For module bracket **MB-50** which offers 2 slots for adding receiver / MP3 module.

### 1-6 Connection with external audio sources

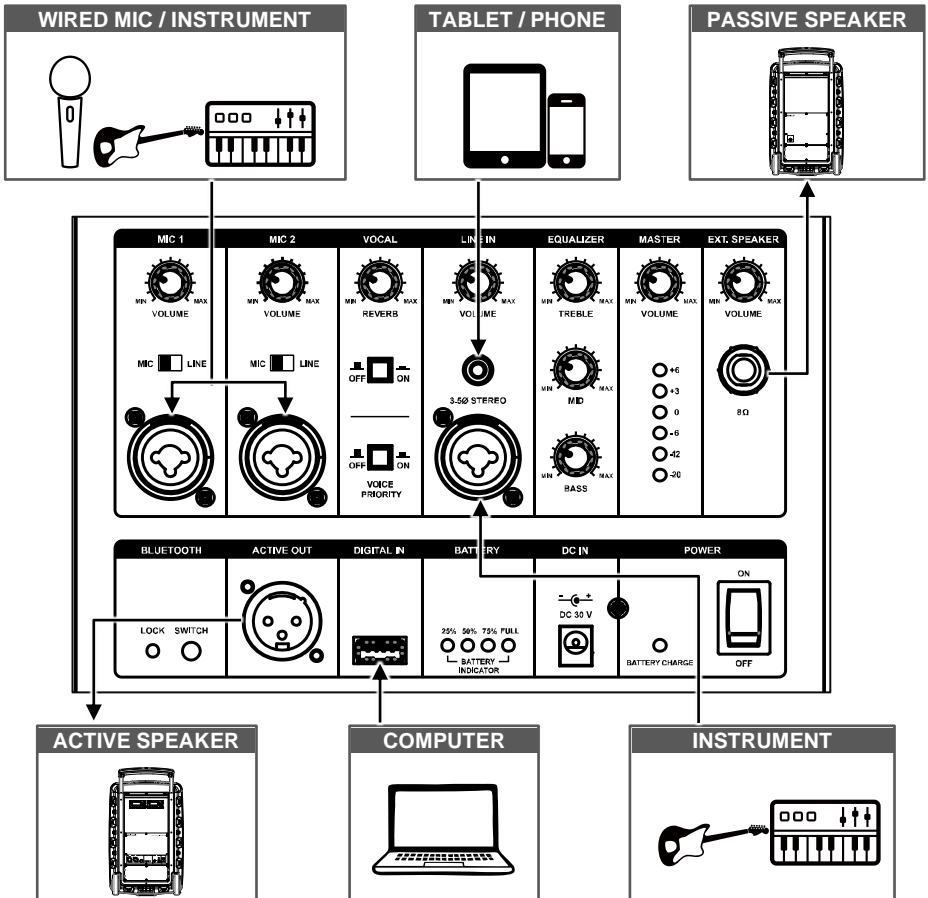



## 2. Settings and Operations

### 2-1 Using the wired microphone (MIC 1, MIC 2)

- 1 Plug a wired microphone with a 6.3mm or XLR connector to **MIC 1** or **MIC 2**.

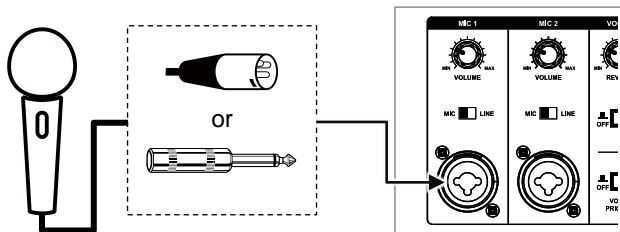

- 2 Slide **MIC/LINE** switch to **MIC** position.

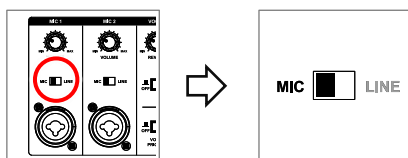

- 3 Turn on master **POWER** and then adjust its individual volume control to a desired level.

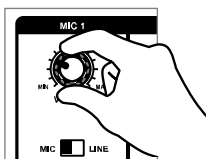

- 4 **TREBLE / MIDDLE / BASS** EQUALIZER (refer to P.17) and **REVERB** (refer to P.18) levels can be adjusted individually.

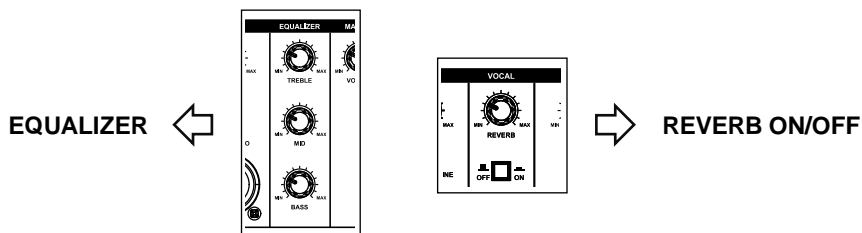

## 2-2 Using the wireless receiver

### 2-2-1 Parts and functions

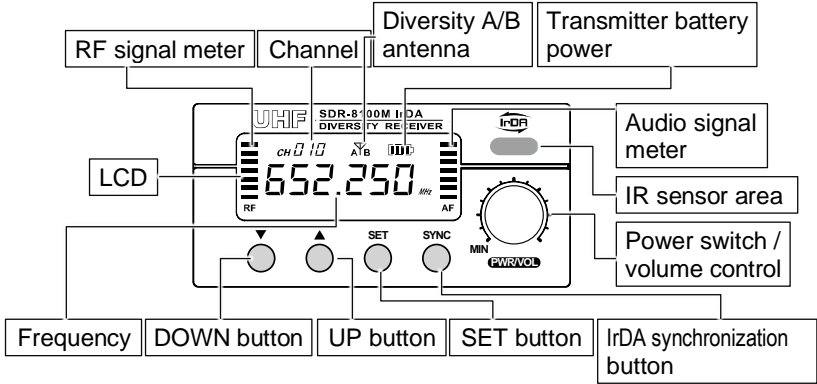

### 2-2-2 Channel synchronization of the receiver and transmitter

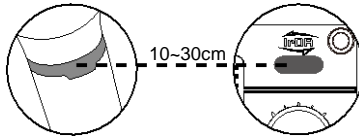

Align infrared areas of the receiver and transmitter within 10~30cm.

#### ■ Changing receiver's channel

- 1 Press the synchronization button of the transmitter.

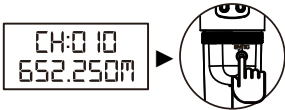

- 2 The transmitter's LED will grow to denote synchronization signal transmitted.



- 3 The channel number on the receiver's LED will become the same as the transmitter's, which means the receiver has been successfully synchronized.

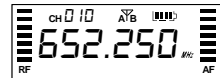

#### ■ Changing transmitter's channel

- 1 Press the SYNC button of the receiver.

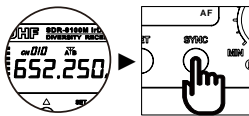

- 2 The transmitter's LED will grow to denote synchronization signal received.



- 3 The channel number on the transmitter's LCD will become the same as the receiver's, which means the transmitter has been successfully synchronized.

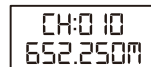

If it doesn't work check that you have the IR sensor panels aligned, that they are facing each other, devices are within 10~30cm of each other, and try again.

### 2-2-3 Channel scanning

For an interference-free operation, a cleaner channel might be necessary if the current one receives too much interference. To operate the scanning:

- 1 Press ▼(down) or ▲(up) button to make the frequency icon **FREQ** appear on the bottom.

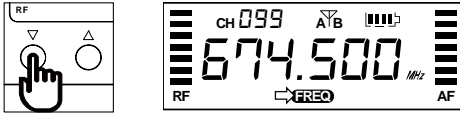

- 2 Hold **SET** button until this icon **FREQ** flashes to denote readiness for setting.

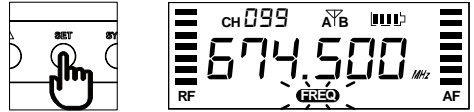

- 3 Press ▼(down) or ▲(up) button to find and locate a clear, interference-free channel.

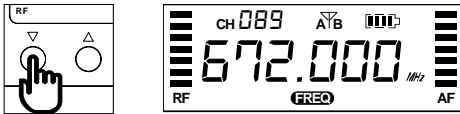

- 4 After a channel is chosen, press **SET** button or wait 5 seconds to store the setting.

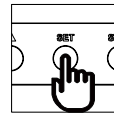

### 2-2-4 Squelch (SQ) setting

When interference is encountered try reducing the sensitivity of the receiver, thus less susceptible to interference. To operate the squelch setting:

- 1 Press ▼(down) or ▲(up) button to turn to the squelch setting page.

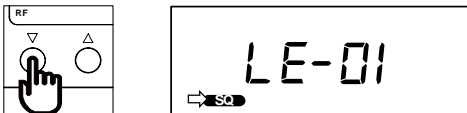

- 2 Hold **SET** button until this icon **SQ** flashes to denote readiness for setting.

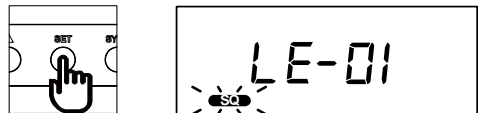

- 3 Press ▼(down) or ▲(up) button to select a new squelch level between **01** and **10**. The default level is **01**.

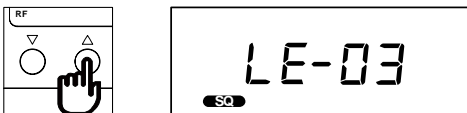

- 4 After a level is chosen, press **SET** button or wait 5 seconds to store the setting.

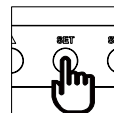

Since increasing the squelch level will also reduce the reception distance, it's recommended to choose the lowest level that can eliminate the interference. If this still does not solve the problem it means this frequency is not suitable. Adjust the squelch back to its default level (**LE-01**) and use the scan function to locate a clear, interference-free channel.

## 2-2-5 Volume and other settings

- 1 Turn on master POWER and then adjust its individual volume control to a desired level.

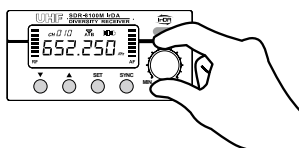

- 2 TREBLE / MIDDLE / BASS EQUALIZER (refer to P.17) and REVERB (refer to P.18) levels can be adjusted individually.

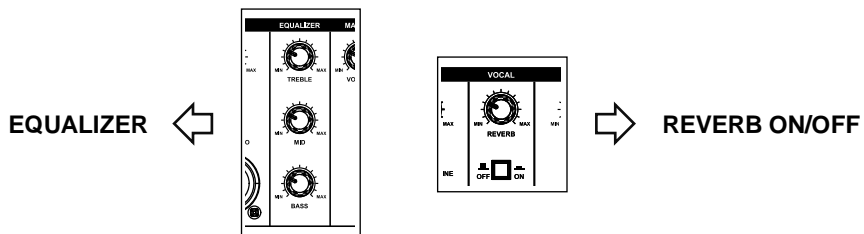

## 2-3 Using the electronic instrument (MIC 1, MIC 2)

- 1 Plug an electronic guitar / keyboard with a 6.3mm or XLR connector to **MIC 1** or **MIC 2**.

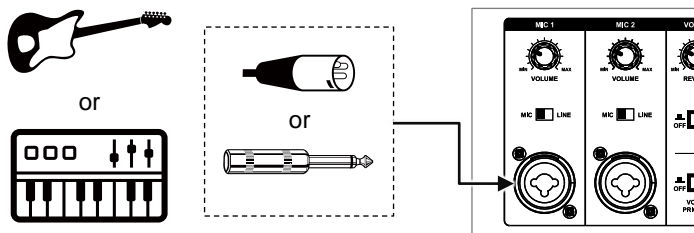

- 2 Slide **MIC/LINE** switch to **LINE** position.

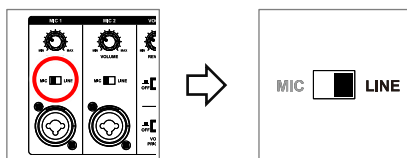

- 3 Turn on master **POWER** and then adjust its individual volume control to a desired level.

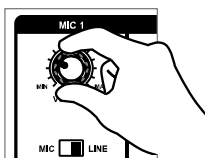

- 4 **TREBLE / MIDDLE / BASS** EQUALIZER levels can be adjusted individually. (refer to P.17)

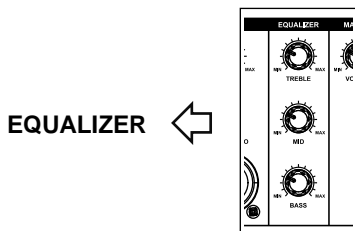

## 2-4 Using the electronic instrument (LINE IN)

- 1** Plug an electronic guitar / keyboard with a 6.3mm or XLR connector to the COMBO jack of **LINE IN**.

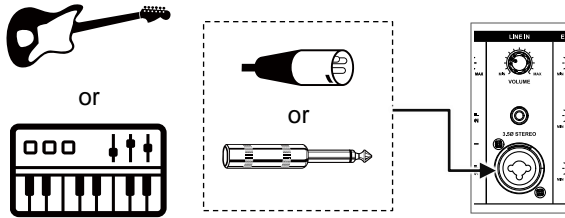

- 2** Turn on master POWER and then adjust its individual volume control to a desired level.

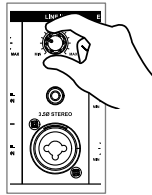

- 3** TREBLE / MIDDLE / BASS EQUALIZER levels can be adjusted individually. (refer to P.17)

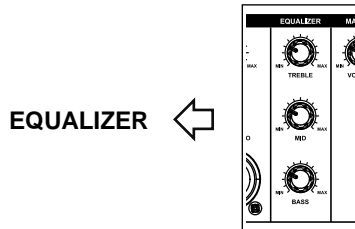

## 2-5 Music audio input (LINE IN)- Smart phone / tablet / MP3 player

- 1** Plug the audio cable a 3.5mm phone plug to the 3.5mm jack of **LINE IN**.

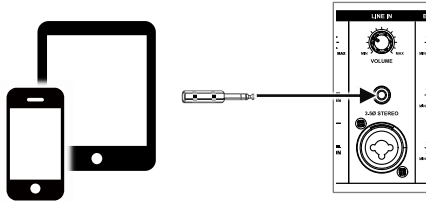

- 2** Turn on master POWER and then adjust its individual volume control to a desired level.

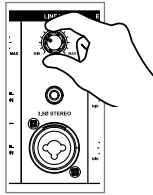

- 3** TREBLE / MIDDLE / BASS EQUALIZER levels can be adjusted individually. (refer to P.17)

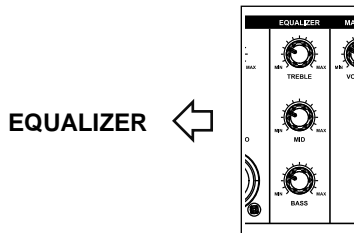

## 2-6 Music audio input (DIGITAL IN)- Computer/notebook

- 1 Use a USB cable to connect the unit and your PC/Notebook to use APEX PRO as the speaker of your device.

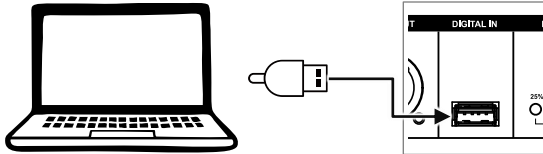

- 2 Turn on master POWER and then adjust master volume control to a desired level.

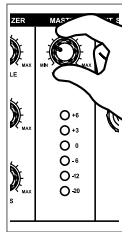

- 3 TREBLE / MIDDLE / BASS EQUALIZER levels can be adjusted individually. (refer to P.17)

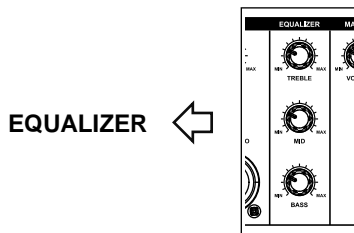



## 2-7 Operating BLUETOOTH receiver (BLUETOOTH)

- 1** Turn on master POWER and then press the **SWITCH** button 3 seconds to turn on the BLUETOOTH receiver. The pairing indicator will flash green.

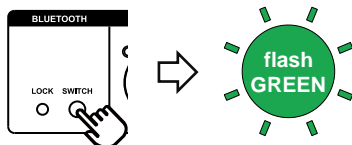

Approximately 9 seconds later, the pairing indicator flashes green and red, which means it is ready for pairing.

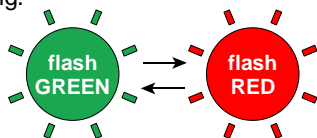

- 2** Activate BLUETOOTH on your device (phone, tablet, PC., etc) and pair with external BLUETOOTH device named "**BT AUDIO**". After successful linking, the pairing indicator will be solid green and you can play your music on **APEX PRO**.

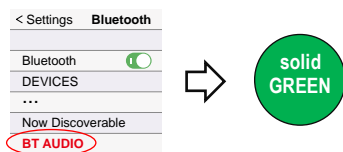

- 3** Adjust master volume control to a desired level.

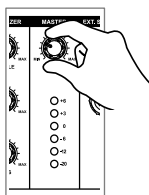

- 4** TREBLE / MIDDLE / BASS EQUALIZER levels can be adjusted individually. (refer to P.17)

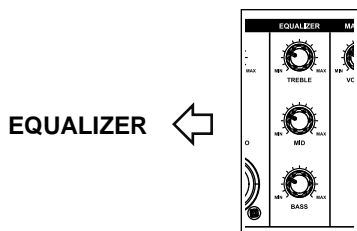

**Important**

- The BLUETOOTH automatically turns off after no pairing for 5 minutes.
- Press **SWITCH** button for disconnection and getting ready for new pairing.
- The BLUETOOTH can memorize and automatically connect to last-paired device.

**2-8 EQUALIZER for WIRED and WIRELESS MICROPHONE and MUSIC**

EQUALIZER adjustment is actually used to increase or reduce the high/medium/low frequency component of the speaker's restored sound. It is so-called raising or attenuating TREBLE/BASS via frequency-specific volume knobs to improve human voices or make musical instruments' sound more prominent. According to the scale marks on the panel, clockwise adjustment is to increase and boost and opposite direction to decrease and attenuate.

Adjust the level of high frequency (TREBLE), middle frequency (MIDDLE), and low frequency (BASS) respectively. All signals have been balanced by the high and low sounds after entering the amplifier so it is not necessary to adjust the EQUALIZER during the output to the speaker. It is recommended to maintain the position of BASS, MIDDLE and TREBLE at just 12 o'clock.

<b>KNOBS</b>	<b>BASS</b>	<b>MIDDLE</b>	<b>TREBLE</b>
<b>FUNCTION</b>	increase or reduce the low frequency component of the sound	increase or reduce the medium frequency component of the sound	increase or reduce the high frequency component of the sound
<b>RANGE</b>	-12 dB ~ +12 dB		
<b>DEFAULT</b>	12 o'clock		

Adjustment reference:

- **BASS:** It is the basic part of the sound. It accounts for 70% of the entire audio energy and is an important component to display the music style. When appropriate, the BASS is relaxed and the sound is full and soft. If you feel the sound is thin, you can moderately increase the BASS. If you feel the sound is muffled, not clear, or too nasal, you can moderately reduce the BASS.
- **MIDDLE:** Containing the low harmonics and overtones of most musical instruments. It is the characteristic sound of snare drums and percussion instruments. The sound is clear and bright when appropriate. If you feel the sound is blurred, you can moderately increase the MIDDLE. If a phone-like sound appears, you can moderately reduce the MIDDLE.
- **TREBLE:** It's the frequency that affects the sound layering. If you feel that the sounds of instruments such as Piccolo and Flute are too prominent, or the tooth sound of the voice is too heavy and the tone is sharp, you can moderately reduce the TREBLE.

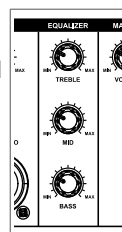

## 2-9 VOICE PRIORITY



Voice Priority operation is only necessary when CD/USB/MP3 is playing. When the Voice Priority switch is ON, the ducking function will be activated. While the music is playing, a voice input from either a **WIRED or WIRELESS MICROPHONE** will temporarily override and lower the volume of the background music and voice could be heard more clearly. Background music will return to its original setting when no audio input is entering the microphone after certain seconds. However, if the microphone is not switch off, the reentering of music into the microphone will also activate the voice priority function.



## 2-10 REVERB



This function can add extra depth to the sound of **WIRED or WIRELESS MICROPHONE** to create a realistic acoustic ambience. You can adjust the reverb depth by using the REVERB knob. The depth range is from MIN through MAX. The MIN level produces no effect, while MAX level produces maximum reverb depth. When REVERB is turned off, no effect is applied.

## 2-11 Limiter Function

The function of the limiter is to maintain a certain output level of the signal below a specific maximum in order that the output of this pre-amplified signal level is effective while preventing sound distortion and avoiding the speaker from breaking or malfunctioning due to excessive load. The purpose of the six input signal source (microphone, musical instrument or music) signal level indicators, from -20dB (min) to +6dB (max), is to display the real-time dynamic level of the sound signal. Please do not exceed the 5th indicator (+3dB) flashing when adjusting the volume of each input to prevent distortion.

Normal volume				 nearly distortion	 distortion
<input type="radio"/> +6 <input type="radio"/> +3 <input type="radio"/> 0 <input type="radio"/> -6 <input type="radio"/> -12 <input checked="" type="radio"/> -20	<input type="radio"/> +6 <input type="radio"/> +3 <input type="radio"/> 0 <input type="radio"/> -6 <input checked="" type="radio"/> -12 <input checked="" type="radio"/> -20	<input type="radio"/> +6 <input type="radio"/> +3 <input type="radio"/> 0 <input checked="" type="radio"/> -6 <input checked="" type="radio"/> -12 <input checked="" type="radio"/> -20	<input type="radio"/> +6 <input type="radio"/> +3 <input checked="" type="radio"/> 0 <input checked="" type="radio"/> -6 <input checked="" type="radio"/> -12 <input checked="" type="radio"/> -20	<input type="radio"/> +6 <input checked="" type="radio"/> +3 <input checked="" type="radio"/> 0 <input checked="" type="radio"/> -6 <input checked="" type="radio"/> -12 <input checked="" type="radio"/> -20	<input checked="" type="radio"/> +6 <input checked="" type="radio"/> +3 <input checked="" type="radio"/> 0 <input checked="" type="radio"/> -6 <input checked="" type="radio"/> -12 <input checked="" type="radio"/> -20

### 3. Application

#### 3-1 Active audio link: APEX PRO to APEX PRO

APEX PRO operates as the MASTER as well as companion unit in an audio link (wired) configuration.

- 1 Connect one APEX PRO after the other via the COMBO LINE IN and ACTIVE OUT jacks.

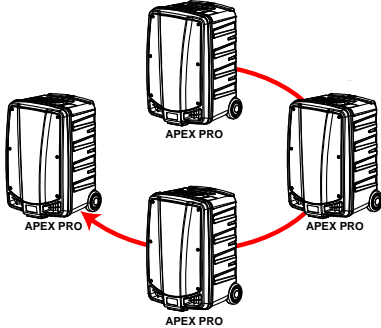

#### Important

- Max cable length:  $\leq 20\text{m}$
- Recommended linking no more than 5 units. Too many units may result in audio delay.

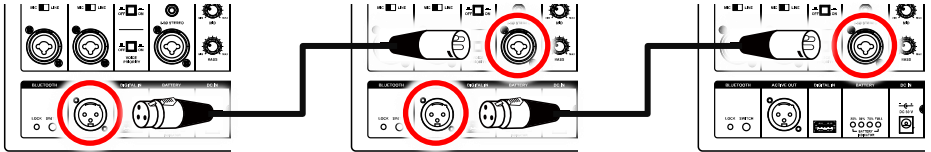

- 2 Turn on master POWER of EACH APEX PRO and then adjust master volume control to a desired level.

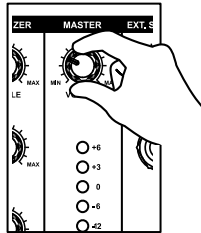

- 3 TREBLE / MIDDLE / BASS EQUALIZER levels can be adjusted individually. (refer to P.17)

EQUALIZER ←

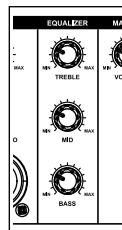

### 3-2 Active audio link: APEX PRO to APEX SLAVE

**APEX PRO** operates as the MASTER unit in an audio link (wired) configuration with active companion powered speakers **APEX SLAVE**.

- 1 Connect the **APEX PRO** (master unit) and **APEX SLAVE** (active companion powered speakers) via **ACTIVE OUT** and **ACTIVE IN** jacks.

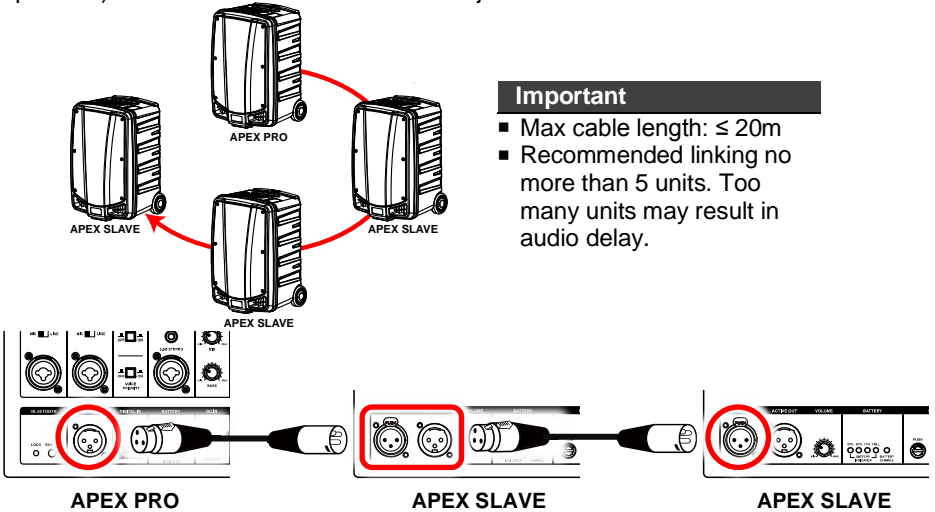

- 2 Turn on master **POWER** of **APEX PRO** and **EACH APEX SLAVE** and then adjust master volume control to a desired level. Turn on power of **EACH APEX SLAVE** and then adjust the volume control to a desired level.



- 3 **TREBLE / MIDDLE / BASS** EQUALIZER levels can be adjusted individually. (refer to P.17)

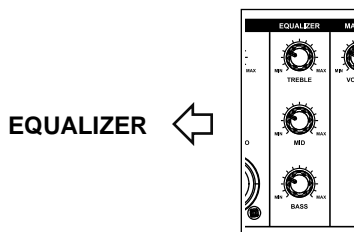

### 3-3 Wireless audio link: repeat all audio to linked APEX PRO / APEX SLAVE

**APEX PRO** operates as the MASTER unit in a wireless audio link with other **APEX PRO** or active companion powered speakers **APEX SLAVE**.

The repeater module **RP-5100M** of master **APEX PRO** can transmit all audio signals, including wired/wireless microphone, music, instrument etc., to other units installed with receiver module.

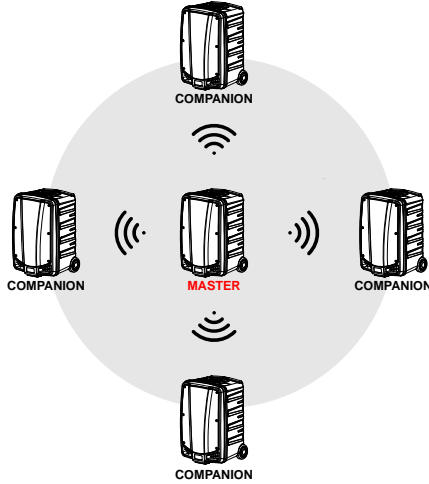

#### 3-3-1 Parts and functions of RP-5100M

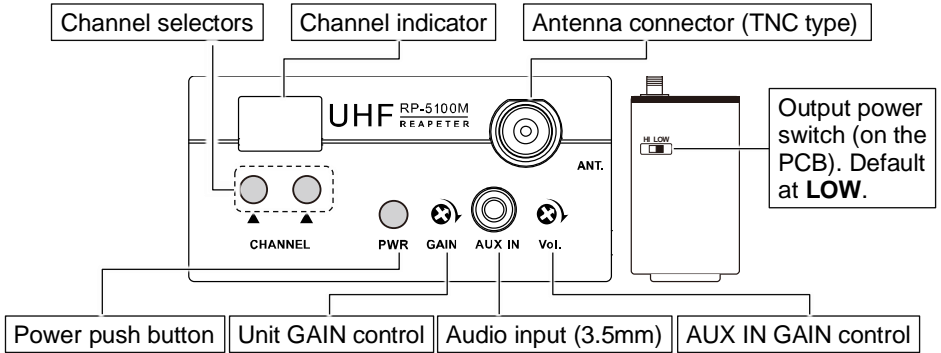

#### 3-3-2 Changing channels

Press LEFT ▲ button to increase the TENS-digit channel number.

Press RIGHT ▲ button to increase the UNIT-digit channel number.

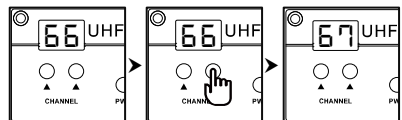
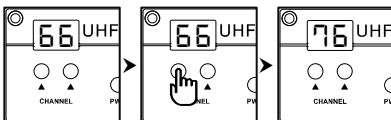

### 3-3-3 Music audio input (AUX IN)- Smart phone / tablet / MP3 player

- 1 Connect your device to the 3.5mm jack of **AUX IN** with a 3.5mm **3-pole stereo** audio cable.

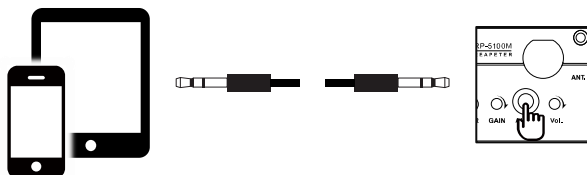

- 2 Use a mini screw driver to adjust the volume of the input audio.

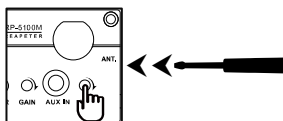

### 3-3-4 Adjust internal audio gain level

Use a mini screw driver to adjust the volume of audio sources in the master unit.

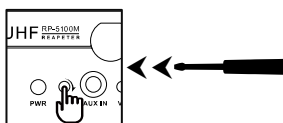

### 3-3-5 Output power setting

- **LOW** position (default) for low output power and **HI** for high output power.
- Low output power will reduce the RF transmission distance and high output power will extend the possible RF transmission distance.
- If the module is installed on battery-powered amplifiers, remember HIGH output power places slightly more load on the battery and will reduce operating duration faster than LOW output power.

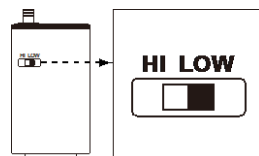

- 1** Install a repeater module **RP-5100M** on the master **APEX PRO**. Set the channel/frequency on the repeater module which will be used to transmit signals to other units. The channel/frequency must be different from other modules on all master and companion units.

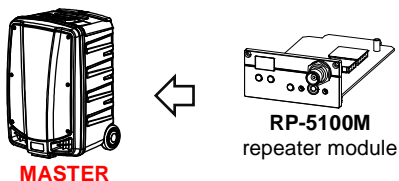

- 2** Install a receiver module **SDR-8200M/8100M IrDA** on companion **APEX PRO** or **APEX SLAVE**. Set the channel/frequency on the receiver module which will be used to receive signals from the master **APEX PRO**. Both repeater and receiver module must be the same channel/frequency.

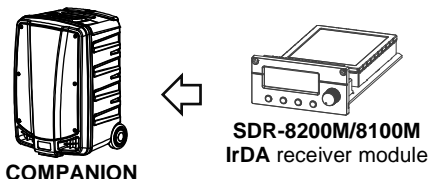

- 3** Turn on master **POWER** of **APEX PRO** and **EACH APEX SLAVE** and then adjust master volume control to a desired level. Turn on power of **EACH APEX SLAVE** and then adjust the volume control to a desired level.



- 4** **TREBLE / MIDDLE / BASS** EQUALIZER levels can be adjusted individually. (refer to P.17)

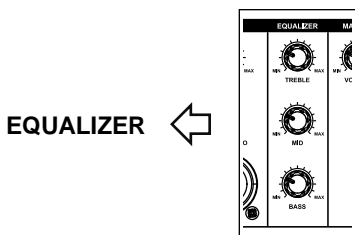



### 3-4 More extension

To reach wider coverage, the companion unit **APEX PRO / APEX SLAVE** can serve as SUB-MASTER to transmit signals to SUB-COMPANION units.

**Important:** Please do not set the SUB-COMPANION as next MASTER in order to guarantee best sound quality.

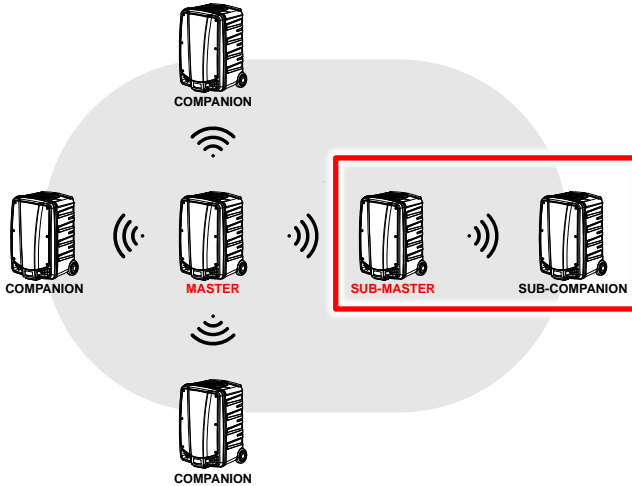

For this purpose, please install a repeater module on the SUB-MASTER unit and a receiver module on SUB-COMPANION units (same procedures as STEP 1 & 2). Both repeater and receiver module must be the same channel and same frequency which must be different from former repeater and receiver module.

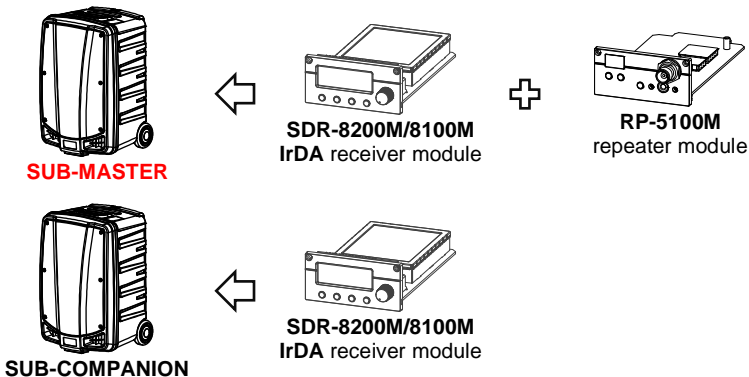

### 3-5 Connecting a passive companion speaker

- 1 Plug the passive companion speaker's audio cable with a 6.3mm connector to the speaker input socket of **APEX SP** or another 4~8Ω load speaker. Max cable length less than 20m.

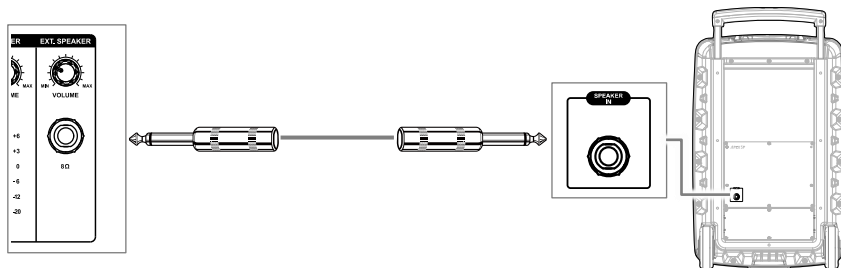

- 2 Turn on master POWER and then adjust its individual volume control to a desired level.

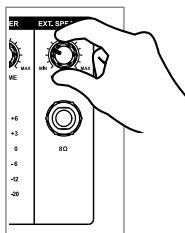

- 3 TREBLE / MIDDLE / BASS EQUALIZER levels can be adjusted individually. (refer to P.17)

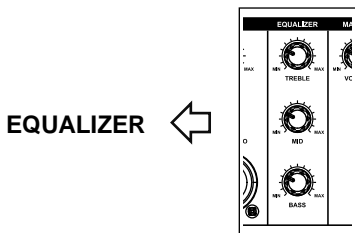

#### 4. Installing or replacing a receiver/repeater/MP3 module

There are four slots above the control panel and two on **MB-50** module bracket for installing optional modules which includes receiver, repeater and MP3 recorder modules.

- 1 Use a Phillips-head screwdriver (not included) to remove the screws of the blank cover panel or current module's panel.

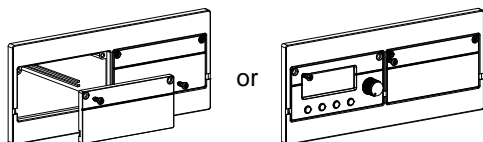

- 2 To replace module, use a mini flat-head screw driver (not included) to pry up the current module's panel and remove the module.

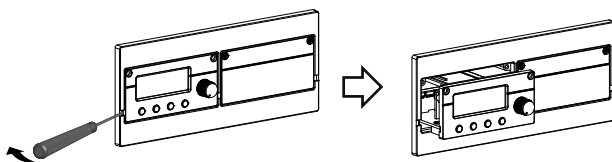

- 3 Gently insert the module into the slot by aligning its edges to the guide rails. Then push the panel to make sure it's been firmly connected.

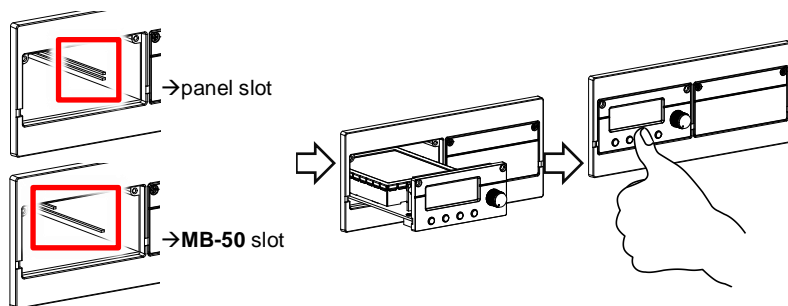

- 4 Tighten up the screws.

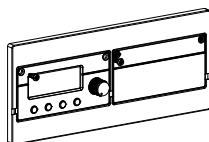

## 5. Operation of the storage for transmitters and accessories

- 1** Open the lid. Be careful of the gap between the trolley handle and the lid.

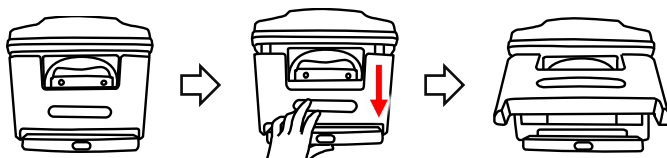

- 2** Slots **1**~**4** for handheld transmitters. Please make the handheld's power switch face the amplifier's handle and then insert. Slot **5** for switching power supply. Slots **6** for power cable.

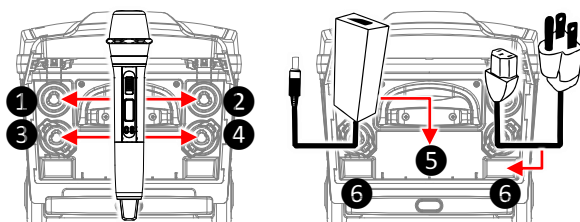

- 3** Slots **3**~**4** also for backpack transmitters. Before inserting a backpack transmitter, please make it UPSIDE DOWN and turn 45° to insert the antenna first.

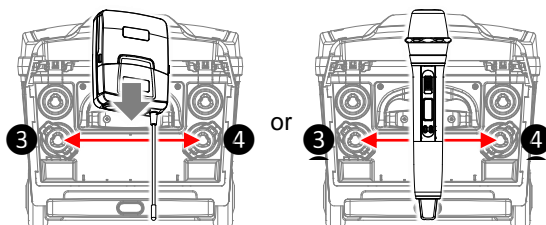

- 4** After everything is correctly placed, return and close the lid. Please be noted that the lid will be unable to recover if anything inside the container is misplaced.

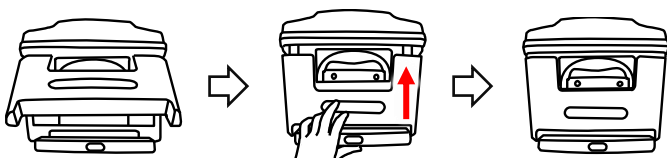

## 6. FAQ & useful operation tips

### 1 How to adjust the best volume?

For CHIAYO PA system with a master volume control, turn the master volume to 12 o'clock and then gradually adjust the volume of audio inputs (microphone, CD, MP3, etc.) from minimum to an appropriate level. Then adjust master volume on demand of application. CHIAYO PA systems have volume distortion indicators that prevent distortion even at maximum volume.

### 2 Is it possible to play music storing on external devices via wireless amplifier?

Yes. CHIAYO's wireless amplifiers have auxiliary audio input(s) LINE IN (or AUX IN) for connection with external devices such as notebook, mobile phones or tablets. (Medium and larger-sized wireless amplifiers (**APEX**, **STAGE** and **FOCUS** series) can also be installed with MP3 recorder modules and equipped with remote control for more versatile functionality.) Music streaming from mobile phone / tablet / notebook is available via built-in BLUETOOTH receiver.

### 3 How to avoid or reduce feedback?

■ Do not stand in front of the speaker when using the microphone.

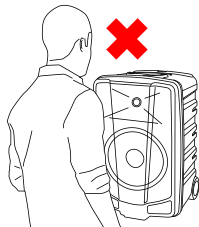

■ Do not point the wireless microphone towards the speaker.

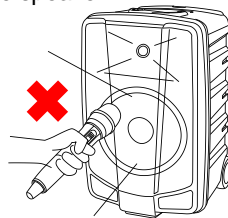

■ Use the microphone behind the speaker as possible.

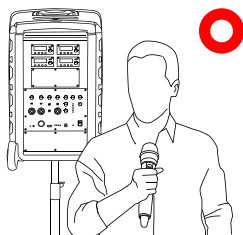

■ Locate the wireless amplifier between the speaker and the audience with the speaker facing the crowd. Place the wireless amplifier on a tripod stand and above the head of audience (about 180cm).

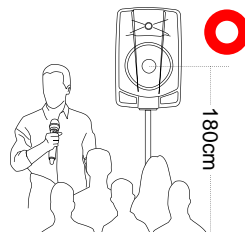

■ Turn down the volume if necessary.

**4 Is it possible to record the sound of Microphone or external devices when using APEX PRO?**

Yes. Install an MP3 recorder player (DPR-500m) on APEX PRO to obtain recording function.

---

**5 Does a wireless amplifier need to be installed with a tripod? What is the ideal height for Amplifier above the ground?**

Higher position of a wireless PA will be helpful for signal reception. It can be mounted on the tripod and above the ear or head of the audience. If the tripod is not allowed on site, you can also raise it on a table or a flat object while the amplifier leaves the ground by 1 meter or more.

---

**6 Will wireless amplifier automatically power off once it is fully charged? Do I need to unplug the power cord?**

Yes. Since all CHIAYO amplifiers have an overcharge protection circuit that automatically power off at full charge and prevent damage to the system. However, please unplug the power cord after fully charging to ensure the safety.

---

**7 How to charge and maintain the battery of wireless amplifier?**

After plugging the power cable of the wireless amplifier into a standard outlet, the charging LED will glow or flash indicative of charging status. The wireless amplifier can be charged whether in use or power off.

Lead-acid batteries/lithium batteries have no memory effect. Please charge them up immediately after each use, no matter how much power they left. If the battery is not charged for a long time, it may cause the battery to be over-discharged and damaged, shortening the battery life or even making it impossible to charge normally.

Lithium battery should be fully charged at least once every 6 months. Lead-acid battery should be fully charged at least once every 3 months.

If the battery is fully charged after usage without over-discharging, the battery life can reach about 2 years.

---

**8 Is it possible that APEX PRO can work as amplifier only? Can I use only one or more microphones? How many wireless microphones can be used at most?**

The wireless receiver, transmitter and MP3 recorder player (DPR-500m) for **APEX PRO** are modular products which can be installed optionally according to application and requirement.

Maximum 4 wireless microphones can be used simultaneously.

---

**9 What is the difference between lead-acid batteries and lithium batteries?**

Lithium battery: light weight, electronic circuit protection, long life and more expensive.  
Lead-acid battery: heavy weight, short life and more affordable.

## 7. Maintenance-free Lead-acid and Lithium batteries

### Cautions when using the battery

1. Lead-acid batteries/lithium batteries have no memory effect. Please charge them up immediately after each use, no matter how much power they left. If the battery is not charged for a long time, it may cause the battery to be over-discharged and damaged, shortening the battery life or even making it impossible to charge normally.
2. Usage temperature can't be lower than  $-10^{\circ}\text{C}$  nor higher than  $50^{\circ}\text{C}$ .
3. It's strictly forbidden to let the battery contact with any liquid. Do not immerse the battery in water or get it wet. After the battery is exposed to water, a decomposition reaction may occur, which may cause battery self-ignition or even cause an explosion.
4. It is forbidden to use the battery when it has swelled, leaked, or the packaging is damaged.
5. It is forbidden to disassemble the battery in any way or pierce the battery with a sharp object, so as not to cause the battery to catch fire or even cause an explosion.
6. The liquid inside the battery is highly corrosive. If it leaks, please do not touch it. If the internal liquid splashes on human skin or eyes, please immediately rinse with clean water for at least 15 minutes before seeking medical attention.
7. It is forbidden to use wires or other metal objects to short-circuit the positive and negative electrodes of the battery.

### Cautions when charging the battery

1. Lead-acid batteries/lithium batteries have no memory effect. Please charge them up immediately after each use, no matter how much power they left. If the battery is not charged for a long time, it may cause the battery to be over-discharged and damaged, shortening the battery life or even making it impossible to charge normally.
2. Please use the power supply specified by CHIAYO for charging.
3. The CHIAYO amplifier has a protection circuit to prevent overcharging. However, it's recommended that the charging time not exceed 12 hours. Please disconnect the power supply when fully charged.
4. Charging temperature can't be lower than  $0^{\circ}\text{C}$  nor higher than  $40^{\circ}\text{C}$ .
5. When charging, please place it on the hard ground, such as cement, and there should be no flammable or combustible materials around. Please pay attention to the charging process to prevent accidents.
6. It will automatically stop charging when fully charged. After the battery is fully charged, it is recommended to disconnect the amplifier from the power supply.
7. When the power supply is not disconnected and the amplifier is not in use, if the battery is fully charged and then recharged again soon after, it means that the battery is aging and cannot store power. Please replace the battery to ensure enough time for operation.

### Cautions when storing the battery

1. Lead-acid batteries/lithium batteries have no memory effect. Please charge them up immediately after each use, no matter how much power they left. If the battery is not charged for a long time, it may cause the battery to be over-discharged and damaged, shortening the battery life or even making it impossible to charge normally.
2. Lithium batteries will automatically discharge in storage. If they are not charged for a long time, they will over discharge that causes a decrease in capacity and damage to the batteries that can no longer be charged normally. It should be fully charged at least once every 6 months.
3. Lead-acid batteries will automatically discharge in storage. If they are not charged for a long time, they will over discharge that causes a decrease in capacity and damage to the batteries that can no longer be charged normally. It should be fully charged at least once every 3 months.
4. Storage temperature can't be lower than  $-10^{\circ}\text{C}$  nor higher than  $40^{\circ}\text{C}$ .

### Disposing the battery

Be sure to completely discharge the battery before placing it in the designated battery recycling bin. Batteries contain dangerous chemicals. When disposing of old batteries, be sure to follow the local battery recycling and disposal regulations, and it is strictly forbidden to put them in a trash can.

**CHIAYO ELECTRONICS CO., LTD.**

Http://www.chiayo.com.tw | Email: sales@chiayo.com.tw  
Office: 30, Lane 27, Section 4, Jen-Ai Road, Taipei 10685, Taiwan  
Tel: 886-2-27415741 | Fax: 886-2-27525242  
Factory: 88, Chung-Hsiao Street 2, Chiayi 60080, Taiwan  
Tel: 886-5-2711000 | Fax: 886-5-5767611



1211395B